



# Multi-point Locks



# About UAP

UAP is a door hardware specialist. We design solutions around our customers' needs, equipping them to navigate the ever-changing fire and security landscape.

We have been driving progress since 1996. Our fire and security solutions - combined with our continual innovation - ensure that our customers are always one step ahead.

Our headquarters and R&D hub are in Manchester - a region synonymous with innovation - and we are proud to serve customers in all corners of the UK.



UAP

# Solutions



## Fire

Stay ahead of the latest fire safety regulations with our unrivalled expertise, industry-leading training, and top-tier fire door hardware solutions.



## Security

Secure the places that matter most with hardware at the bleeding edge of door and window security.



## Innovation

Explore what's next in door hardware with our game-changing products that are driving progress.

## Accreditations



## Awards





40



**OPEN YOUR DOOR  
WITH THE TOUCH  
OF YOUR FINGER**



**A smarter Door Lock with simple access control.**

The IONIC lock by Fullex-ai with timeless design enables simple access using a Smartphone App. The access logins can be easily managed via mobile phone. An additional feature of the app is the access protocol, in which you can see which users have opened the door.

With the integrated power supply and wireless charging, you can open and close the door using BT5 Bluetooth on your mobile phone. The simple and quick installation makes it ideal for factory fitting. You can register infinity number of door openings in the smartphone App and up to 1500 on the lock itself!

Due to the simple installation and the easy-to-use access control, the Ionic electronic lock by Fullex-ai is ideal for any domestic properties and social housing.

Quick and easy installation

User administration and logging via App

Fits every door

GB Granted patent and a European Patent Application

Unlocking via Bluetooth

Dedicated security escutcheon available

Comes with up to 10 year mechanical guarantee



**IMMEDIATE CONFIRMATION**  
**THE DOOR IS LOCKED**



**WIRELESS CHARGING**



**ULTRA SECURE**



**BLUETOOTH COMMUNICATION**



The IONIC Electronic Lock by Fullex-ai is accessible using the Smartphone App which comes with a comprehensive user manual. The App is available to download from Google App Store or Apple Store. It is necessary to turn on the Bluetooth module to use the application. You must turn on the location service too on Android.

The IONIC Electronic Lock by Fullex-ai comes with a key fob which can be paired with the App for even easier door access.

## Technical Data

### Lock Size

- 45mm backset 1720 x 20 mm faceplate for timber, composite or aluminum doors

### Finish

- White, grey and polished chrome effect coming soon

### Access Control:

- Up to 16 normal users + admins
- Up to 16 key fobs
- Time-limited access: between two dates
- Recurring time intervals: 7 time intervals with week days

### Log:

- The lock itself can store maximum 1500 log events (lock, unlock, mains on/off, low battery)

### Settings:

- Auto locking delay
- Button mode (1 or 2 buttons)
- Beep volume change
- Lock name
- Lock firmware update: via Bluetooth directly from the App
- Communication: Bluetooth 5 Low Energy

### Power:

- Wireless (inductive) charger: 5VDC, charge distance max. 5mm
- USB charge: 5VDC
- Built-in battery: 500mAh Li-ion, 3.7V
- Power consumption: 4 mW on standby; 400 mW maximum
- Battery charge time: approx 12h (0 - 100%, from USB or inductive charger)
- Standby operation time without battery recharge present: 3-4 weeks

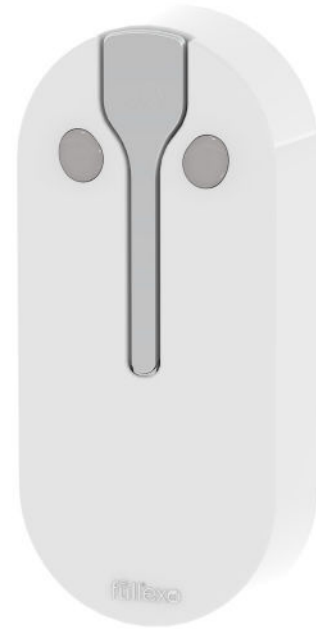

IONIC Electronic Door Lock by Fullex-ai with timeless design enables simple access using the Smartphone App. The access logins can be easily managed via mobile phone. An additional feature of the app is the access protocol, in which you can see which users have opened the door.

Contact UAP Sales at [sales@uapllimited.com](mailto:sales@uapllimited.com) for more information



Download your IONIC Electronic Door Lock by Fullex-ai Smartphone App User Manual



## Opening

You can use an app, a fob, a push button on the inside, an override key or a thumb turn.



# MAKE IT YOUR OWN

## IONIC PACKS

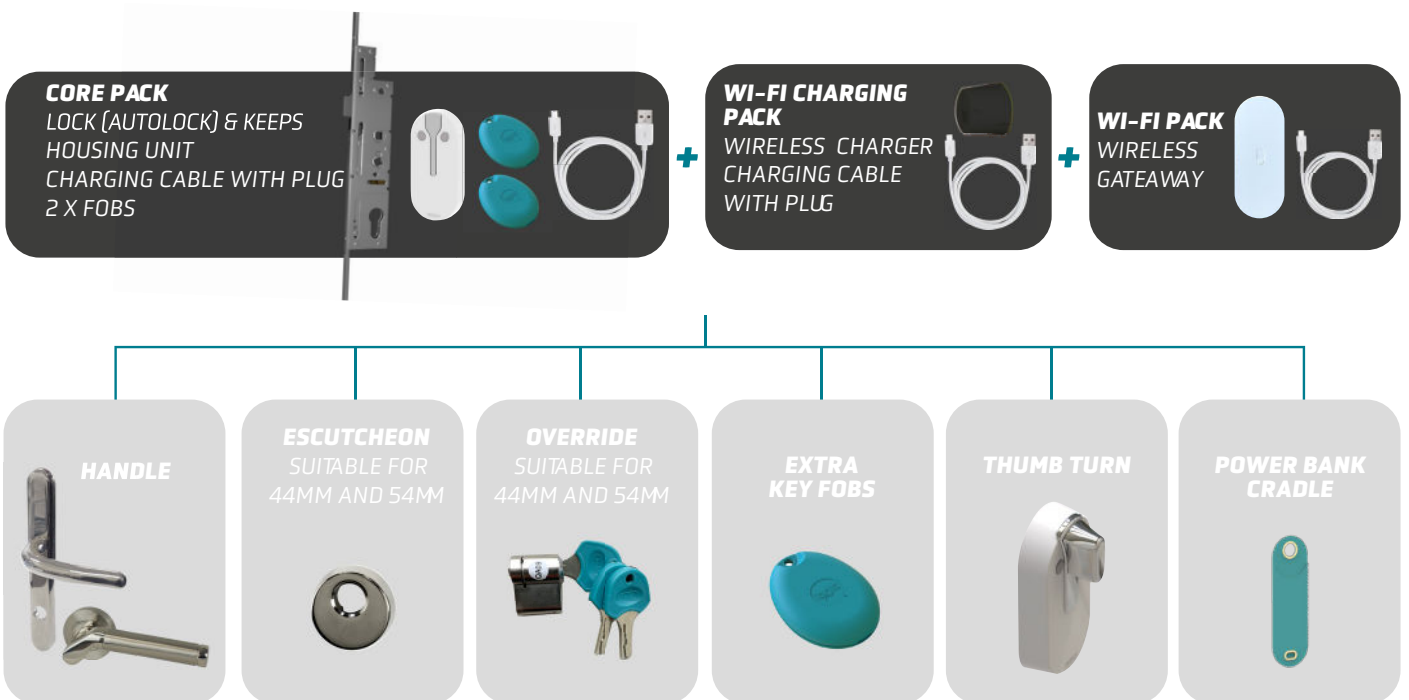

# fullex<sup>®</sup> *Key Wind Lock*

## SINGLE DOORS

The Fullex Key Wind lock uses the key or the thumbturn to engage and retract the bolts and the latch. The Fullex Key Wind lock was developed to stop anyone getting in without a key when the door is closed. Our system uses the latch to do this. Once the door is closed you cannot move the latch unless you have a key. If a burglar tried to open the door, say for example if someone has entered the house with

shopping, then they cannot get in. The Fullex Key Wind Lock have minimum key turning with less than a half a turn.

The Fullex Key Wind Lock system offers low maintenance, economic cost and easy to use functionality.



### Technical Data

45mm backset  
3 dead bolts  
Reversible latch  
Cover plate 20mm wide, 1720mm long

### Top and Bottom Hook

Chrome plated steel top and bottom bolts

### Centre bolt

Stainless steel centre bolt

Based on the Fullex Crimebeater lock

Operated by thumbturn or key-key cylinder

Non-handed easily reversible latch

Designed for use with pull handles

Snib latch retention on face plate

Dedicated security escutcheon available

Comes with a 10 year guarantee

Ideal for doors with a pull handle



The best and most economical system, is having a package of Pull Handle, Key Wind Lock, High Security Escutcheon and 1 Star cylinder, and so we developed a matching escutcheon that fits the Key Wind Lock system.





Faceplate: 1720mm x 20mm (Stainless Steel)  
700mm Centres

Backset Size	No of Hooks	No of Deadbolts	No of Mushrooms	Product Code
45mm	2	3	0	FULLEX-KEYWIND-CRB002

#### ACCESSORIES

Type	Product Code
Security escutcheon Satin	HSESSS-KEYWIND-NANOCOAST
Security escutcheon Mirror Polished	HSEMPSS-KEYWIND-NANOCOAST
UAP Pull Handles	See brochure

#### KEEP SETS

Type	Product Code
Keep Set	CRB0004-KE
Top and bottom keep	XCKS
Right hand centre keep	CRB0013-KE
Left hand centre keep	CRB0014-KE

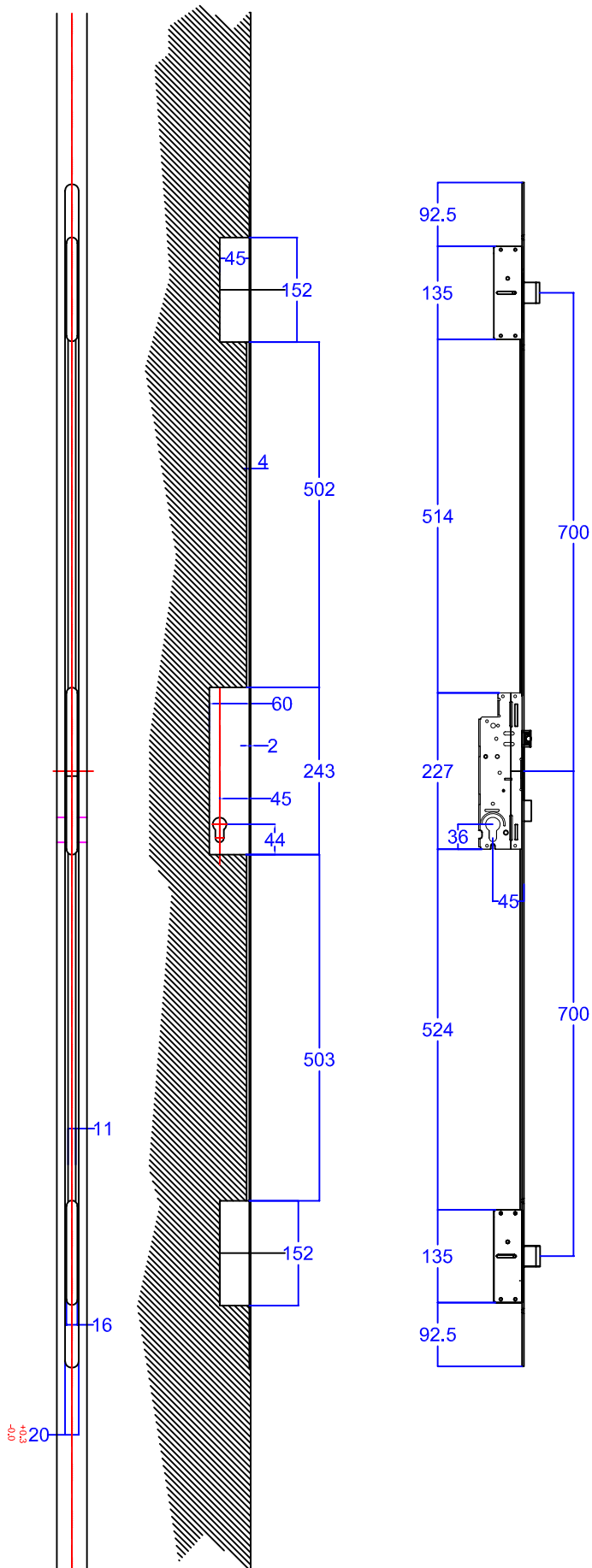

Cylinder preparation.

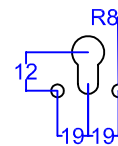
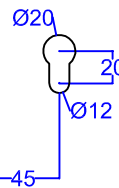

Escutcheon preparation

# fullex<sup>®</sup> XL LOCKS

PVCu Doors

## SINGLE AND DOUBLE DOORS

XL is available in a range of lock configurations and can be used with either one piece or individual keep sets.

The XL's attractive silver finish is also corrosion resistant to neutral salt spray in excess of BS EN 1670 Grade 4, giving peace of mind to hard pressed fabricators and consumers.

One piece or individual keeps

3 opposing steel hooks and two steel anti-lift bolts

Two or four roller cams

Easily reversible latch as standard

Dual, single or split spindle options

Extendable top and bottom as standard

Latch hold back snib on lock faceplate

Comes with a 10 year guarantee

For use on PVCu doors



## Technical Data

### Corrosion Resistance

BS EN 1670 Grade 4 for 240 hours

### Cycle Operation

Cycle tested to 200,000 operations

## Materials

### Top and Bottom Hook

Chrome plated A3 hardened cast steel

### Anti Lift Bolts

Chrome plated A3 hardened cast steel

### Centre Hook

Dacromet coated A3 sintered steel

### Faceplate and Gearbox

Mild steel, zinc and clear passivated

### Roller Cams

Mild steel, zinc and clear passivated

For maximum security this lock can be used with the Kinetica K4 3 star BSI Kitemarked TS007 cylinder.



## Secured by Design



Police Preferred Specification



The XL was designed from the outset to offer maximum security and reliability. XL features three hooks, two steel anti-lift bolts and the option of either two or four roller cams for compression and smooth operation. Every XL lock is extendable top and bottom for

maximum flexibility and when combined with Fullex high security shoot bolts, the XL door system is fully capable of meeting PAS 24 requirements. The XL 3 hook also forms the heart of the CE marked XL Exodus Panic exit system and utilises the same lock preparation.

Faceplate = 2200mm x 16mm (Silver Passivated)

518mm Centres (needs 9 packers)

Spindle	Backset Size	Handle Backplate	Handle Centres	No of Hooks	Anti-Lift Bolts	No of Rollers	No of Mushrooms	Product Code
Dual	35mm	243mm	92mm or 92/62mm	3 (opposing)	2	2	0	XL32R518
Single	35mm	243mm or 219mm	92mm	3 (opposing)	2	2	0	XL32R518SP
Split	35mm	243mm or 219mm	92mm	3 (opposing)	2	2	0	XL32R518S/S

635/572mm Centres (needs 11 packers)

Spindle	Backset Size	Handle Backplate	Handle Centres	No of Hooks	Anti-Lift Bolts	No of Rollers	No of Mushrooms	Product Code
Dual	35mm	243mm	92mm or 92/62mm	3 (opposing)	2	4	0	XL34R6357
Single	35mm	243mm or 219mm	92mm	3 (opposing)	2	4	0	XL34R6357SP
Split	35mm	243mm or 219mm	92mm	3 (opposing)	2	4	0	XL34R6357S/S

650mm Centres (needs 9 packers)

Spindle	Backset Size	Handle Backplate	Handle Centres	No of Hooks	Anti-Lift Bolts	No of Rollers	No of Mushrooms	Product Code
Dual	35mm	243mm	92mm or 92/62mm	3 (opposing)	2	2	0	XL32R650
Single	35mm	243mm or 219mm	92mm	3 (opposing)	2	2	0	XL32R650SP
Split	35mm	243mm or 219mm	92mm	3 (opposing)	2	2	0	XL32R650S/S

735/758mm Centres (needs 11 packers)

Spindle	Backset Size	Handle Backplate	Handle Centres	No of Hooks	Anti-Lift Bolts	No of Rollers	No of Mushrooms	Product Code
Dual	35mm	243mm	92mm or 92/62mm	3 (opposing)	2	4	0	XL34R7474
Single	35mm	243mm or 219mm	92mm	3 (opposing)	2	4	0	XL34R7474SP
Split	35mm	243mm or 219mm	92mm	3 (opposing)	2	4	0	XL34R7474S/S

XL2R2M and XL4R Locks

Spindle	Backset Size	Handle Backplate	Handle Centres	No of Hooks	Dead Bolts	No of Rollers	No of Mushrooms	Product Code
Dual	35mm	243mm	92mm or 92/62mm	0	0	2	2	XL2R2M
Dual	35mm	243mm	92mm	0	0	4	0	XL4RPRO

XL Slave Lock

Spindle	Backset Size	Handle Backplate	Handle Centres	No of Hooks	Anti-Lift Bolts	No of Rollers	No of Mushrooms	Product Code
Single	35mm	243mm or 219mm	92mm	0	0	0	0	XLSL

ACCESSORIES

Description	Old Product Code
120mm lock extension	XLEXT120
400mm roller extension	XLEXT400
PAS24 security plates (pack of 3)	XLSP
2 x Mild steel shoot bolts	XLSEB
2 x Mild steel shoot bolts (low threshold)	XLSEBLOW

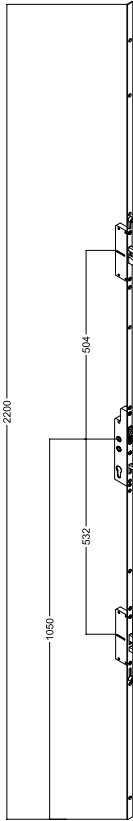

518mm Centres

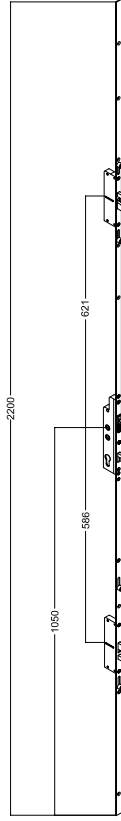

635/572mm Centres

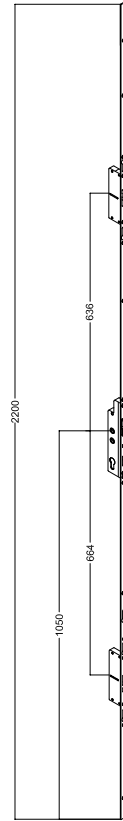

650mm Centres

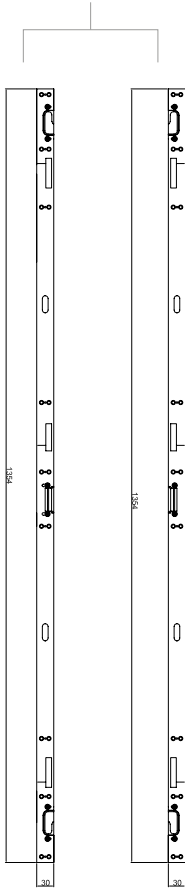

XLK2L518 XLK2R518

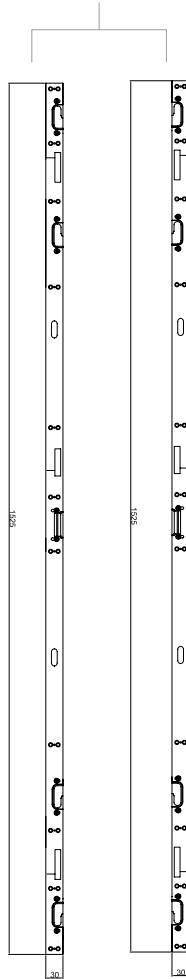

XLK4LTH XLK4RTH

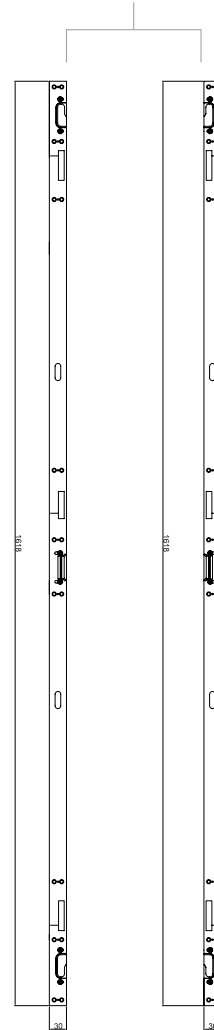

XLK2L650 XLK2R650

# XL KEEPS

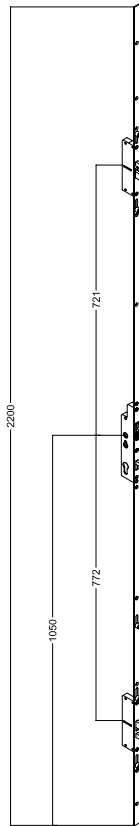

735/758mm Centres

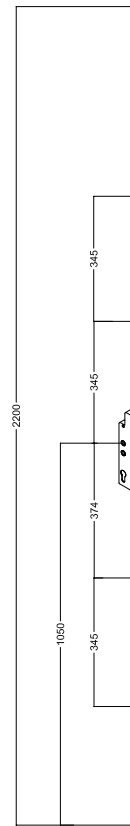

XL2R2M and XL4R

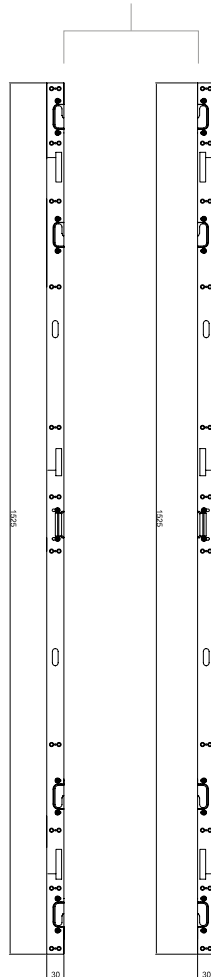

XLK4L7474 XLK4R7474



XLKCL XLKCR

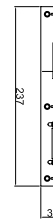

XLKS2R

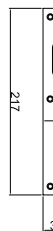
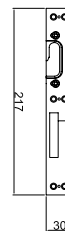

L - Left side keep  
R - Right side keep

# XL SLAVE LOCK KEEPS

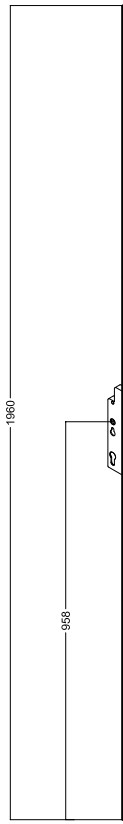

XL Slave  
Lock

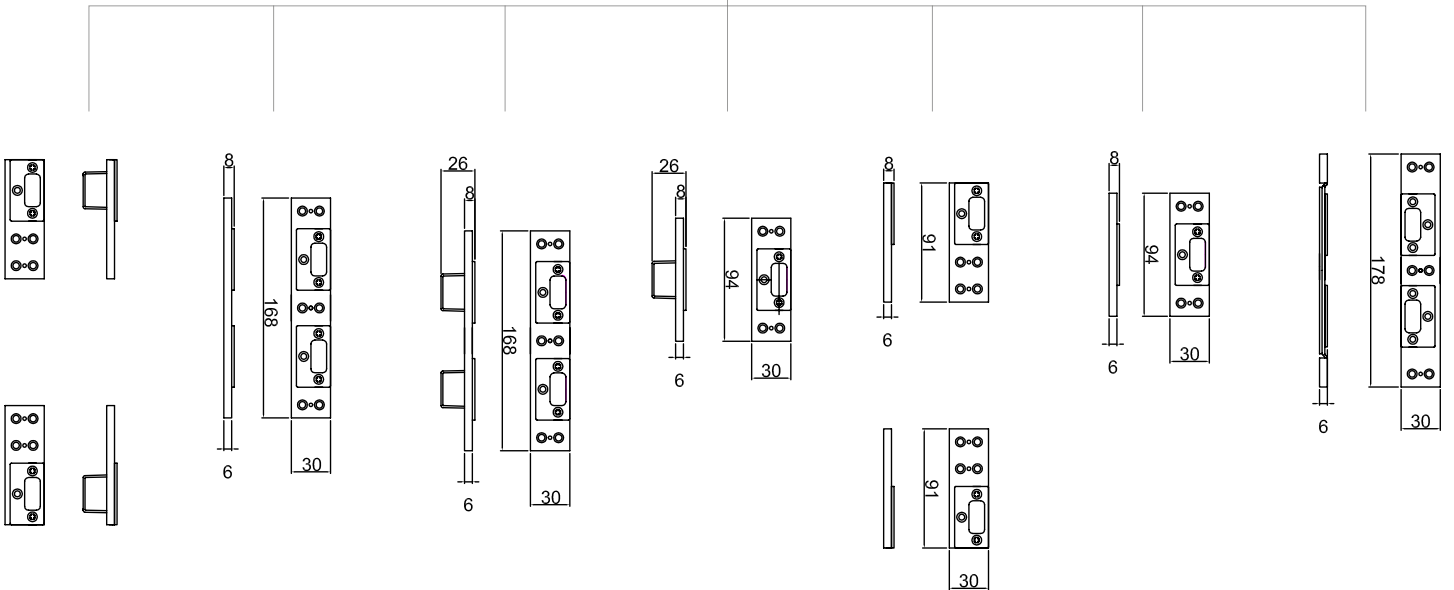

XLKBR SB  
Single door  
shoot bolt  
keep

XLKDSB  
Double shoot  
bolt keep

XLKBDSB  
Double shoot  
bolt keep with  
pockets

XLKSSB  
Double door  
shoot bolt  
keep

XLKRSB  
Single shoot  
bolt keep

XLKBSSB  
Double door  
shoot bolt keep  
with pocket

XLKDSBLOW  
Double door  
shoot bolt  
keep low  
threshold

# fullex<sup>®</sup> XL LOCK PACKERS

Profile	Product Code
Synseal, Rehau 706 and Eurocell WSH Rustique	XLP0001
Duraflex	XLP0002
Decenuninck 2500, Deeplas 2500, Aluplast Ideal and Eurocell Logik + 2mm	XLP0003
Profile 22, LB8000 and Swish	XLP0004
Deeplas 2000 - 2mm	XLP0005
Linear, Kommerling, Deeplas 3000 -1mm, Synseal and Synerji co ex + 2mm	XLP0006
Rehau Tritec, LB700 - 1mm and Selecta	XLP0007
Spectus Elite 70 and HW Elite 70	XLP0008
Halo Eclipse and Esthetique Mullion	XLP0009
Halo Eclipse, Esthetique Outerframe and Thyssen	XLP0010
Veka 70	XLP0011
Deeplas 1800 and Kommerling C70	XLP0012
Synseal Shield	XLP0013
Spectus Sightline	XLP0014
Veka 58 and FS 70 Aluplast Ideal	XLP0015

Profile	Product Code
Profile 22 Mullion	XLP0016
Synseal Legend 70	XLP0017
Plastmo - 2mm	XLP0018
Duraflex - 2mm	XLP0019
Synseal Evolve Q-Ion	XLP0020
Rehau 9mm Axis Mullion and Eurocell Modus Mullion	XLP0021
Synseal Legend 70 - 2mm	XLP0022
Eurocell Ultimate 70	XLP0023
Veka 70 and Synseal Legend 70 - 2mm	XLP0024
Synseal Shield and Synerji co ex	XLP0025
LB 6000 and Eurocell Modus outer frame	XLP0026
Linear + 2mm	XLP0027
WHS Halo System 10 and Rustique	XLP0028
Low profile packer and Eurocell Modus low threshold	XLP0029
Eurocell Modus	XLP0030
Eurocell Modus Mullion	XLP0031
Kommerling C70 385 Mullion	XLP0032

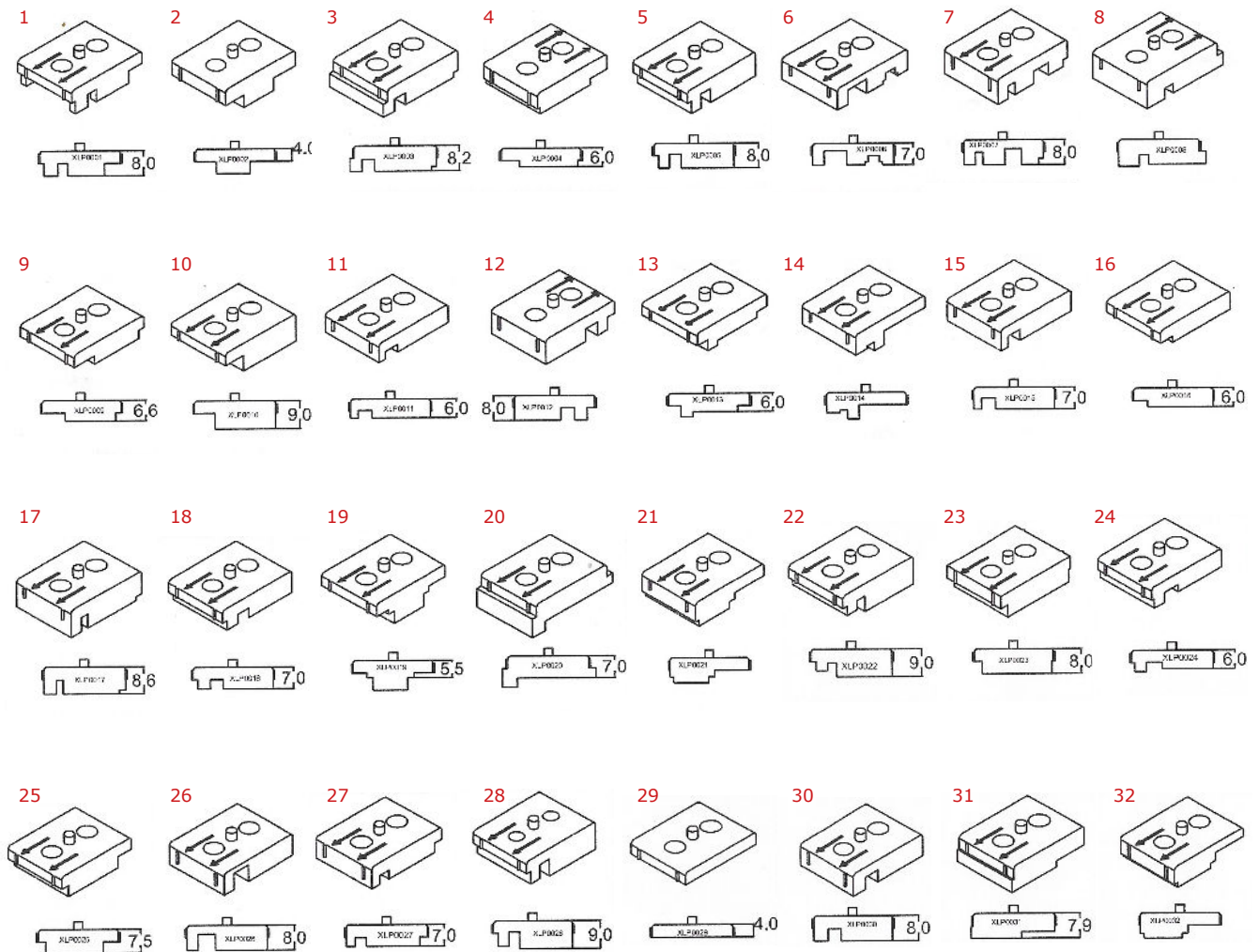

# fullex<sup>®</sup> XL 2+2

PVCu Doors

Aluminium  
Doors

## SINGLE AND DOUBLE DOORS

The XL 2+2 lock and keep were developed by Fullex specifically to suit the Profile 22 Optima system. Based on the successful dual spindle XL lock, which is a direct descendent of the highly regarded Crimebeater range, the XL 2+2 lock shares many components in its design, but adds additional locking elements.

Although similar to the standard XL lock, the XL 2+2 has no roller – compression is achieved by using larger top and bottom bolts to pull the door seals in. It features three opposing steel hooks and two compressing deep throw anti-lift bolts for smooth operation and security. PAS 24 performance on single, double and composite doors.

The one piece stainless steel keep has a completely non-handed design, suitable for PAS 24 testing and is pre-set with permanently attached Profile 22 Optima packers.

Completely non handed design

Suitable for PAS 24 testing

Stainless steel for high corrosion resistance

Pre set to suit profile

Brushed stainless steel finish as specified

Low resistance nylon inserts on keep pockets

Cam adjustment for ease of fitting

3 opposing hooks and 2 compressing deep throw anti-lift bolts

Easily reversible latch with latch snib

Dual spindle



## Materials

### Top and Bottom Hook

Chrome plated A3 hardened cast steel

### Anti Lift Bolts

Chrome plated A3 hardened cast steel

### Centre Hook

Dacromet coated AB sintered steel

### Faceplate and Gearbox

Mild steel, zinc and clear passivated

### Roller Cams

Mild steel, zinc and clear passivated

For maximum security this lock can be used with the Kinetica K4 3 star BSI Kitemarked TS007 cylinder.



## Secured by Design



Police Preferred Specification



Faceplate = 2200mm x 16mm (Silver Passivated)

673/706mm Centres – 2+2 lock (needs 0 packers)

Spindle	Backset Size	Handle Backplate	Handle Centres	No of Hooks	Anti-Lift Bolts	No of Rollers	No of Mushrooms	Product Code
Dual	35mm	243mm	92mm or 92/62mm	3 (opposing)	2	0	0	XL-2+2

### Keep Sets

Handed	Centres	Product Code
Non	673/706mm	XLK2+2 673/706 KEEP

### ACCESSORIES

Description	Product Code
120mm lock extension	XLEXT120
PAS24 security plates (pack of 3)	XLSP
2 x Mild steel shoot bolts	XLSB
2 x Mild steel shoot bolts (low threshold)	XLSBLOW



XLK2+2 673/706 KEEP  
Left or Right Handed

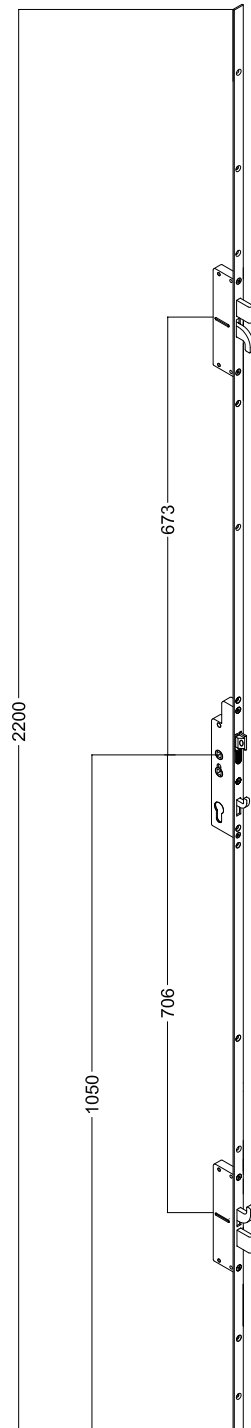
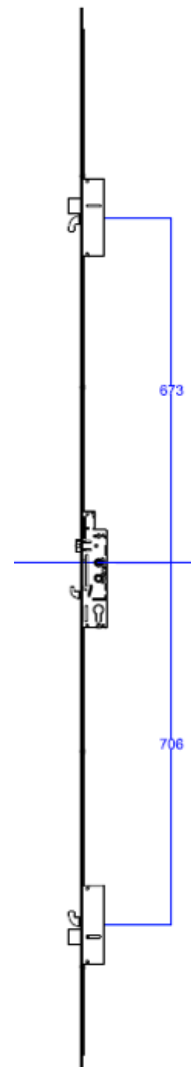

# fullex<sup>®</sup> XL CRIMEBEATER

## SINGLE DOORS

Fullex XL Crimebeater is engineered to provide long term reliability and security.

With 3 hook or 2 deadbolt and 1 hook variants available, in 20mm silver passivated steel or 44mm wrap around white and brown PVCu faceplates, the XL Crimebeater is not only secure but adaptable.

Composite  
Doors

Timber  
Doors

PAS 24 tested

Option 1 - 2 tapered steel hooks,  
latch and sintered centre hook

Option 2 - 2 deadbolts, centre hook and latch

Dual spindle for front / back door options

Easily reversible latch as standard

Integral hold back latch function  
on lock faceplate

Various adjustable security keep  
sets available



### Technical Data

#### Corrosion Resistance

BS EN 1670 Grade 5 (480 hours)

#### Cycle Operation

Cycle tested to 100,000 operations

### Materials

#### Top and Bottom Hook

Chrome plated A3 hardened cast steel

#### Deadbolt

Chrome plated A3 hardened cast steel

#### Centre Hook

Sintered steel

#### Faceplate

20mm silver passivated mild steel  
or 44mm white PVCu

#### Gearbox

Silver passivated mild steel

For maximum security this lock  
can be used with the Kinetica K4  
3 star BSI Kitemarked TS007 cylinder.

### Secured by Design



Police Preferred Specification



The XL Crimebeater is available as a 92/62mm dual spindle for use with 92/92 or 92/62mm long backplate handles.

The 44mm PVCu faceplate version has a matching hinge plate, either blank or prepared for Crimebeater hinges.



Faceplate: 2100mm x 44mm (White PVCu)

Spindle	Backset Size	Handle Backplate	Handle Centres	No of Hooks	No of Deadbolts	No of Mushrooms	Product Code
Dual	45mm	243mm	92mm or 92/62mm	3 (opposing)	0	0	XLC45HK44W7D



Faceplate: 1720mm x 20mm (Silver Passivated)

Spindle	Backset Size	Handle Backplate	Handle Centres	No of Hooks	No of Deadbolts	No of Mushrooms	Product Code
Dual	35mm	243mm	92mm or 92/62mm	1 (up)	2	0	XLC35BT20MS
Dual	45mm	243mm	92mm or 92/62mm	1 (up)	2	0	XLC45BT20MS
Dual	35mm	243mm	92mm or 92/62mm	3 (opposing)	0	0	XLC35HK20MS
Dual	45mm	243mm	92mm or 92/62mm	3 (opposing)	0	0	XLC45HK20MS

### ACCESSORIES

Description	Old Product Code
White uPVC hinge plate 7.5mm	XLCHPLATEW7D
White uPVC hinge plate 7.5mm suit Trojan hinge	XLCHPLATEW7DT
Brown uPVC hinge plate 7.5mm	XLCHPLATEB7D
White plastic hinge infill	CL0097
White plastic infill plus 5mm leg	CL102
Brown plastic hinge infill	CL103

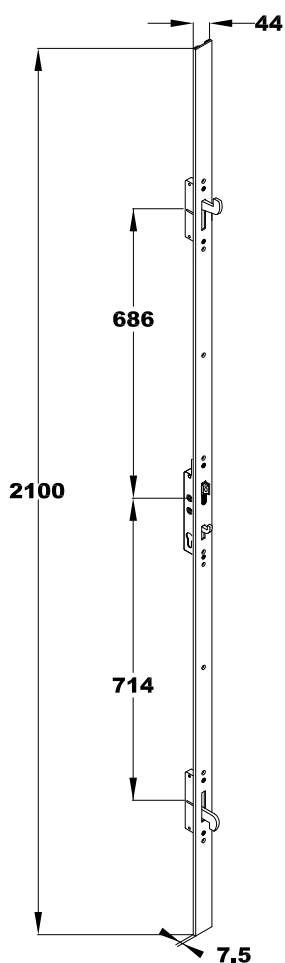

2100mm x 44mm  
White PVCu

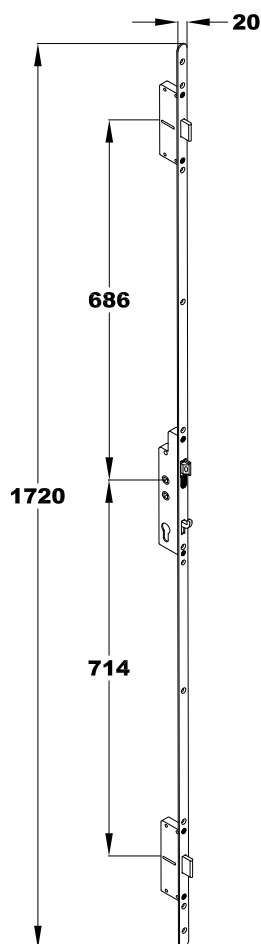

1720mm x 20mm  
Silver Passivated

# KEEPS

## RADIUS

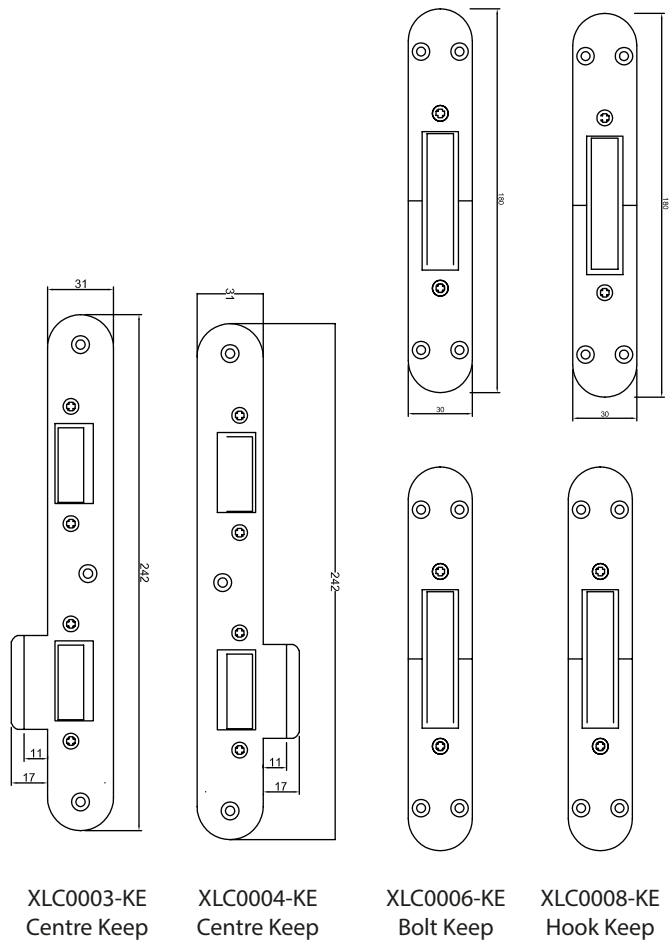

Ideal for Timber on the XLC Lock options.

### XL CRIMEBEATER

2100mm x 44mm  
White PVCu

1720mm x 20mm  
Silver Passivated

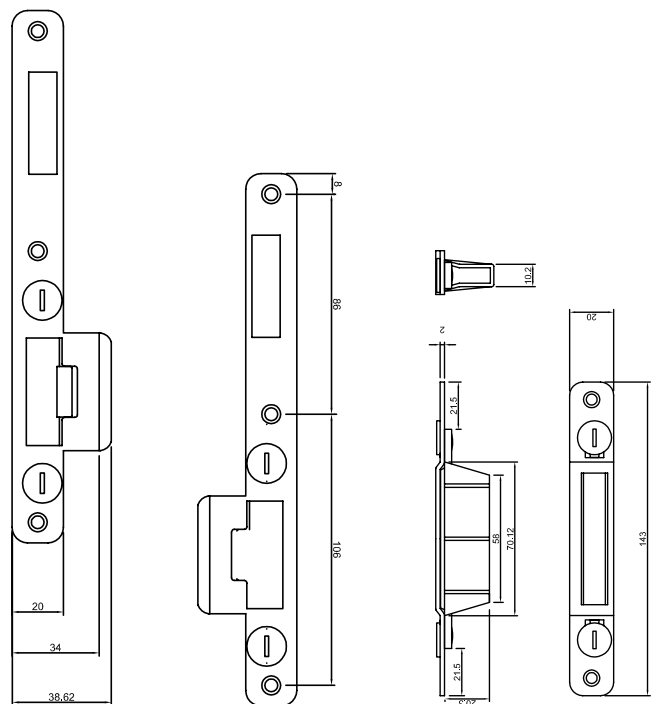
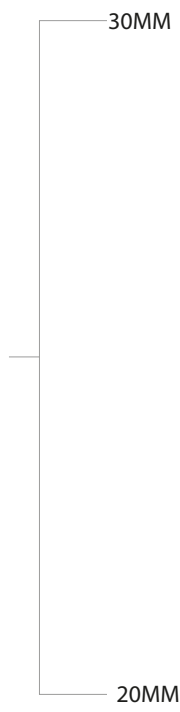

XCKCR

XCKCL

XCKS  
Bolt Keep

# KEEPS

## SQUARE

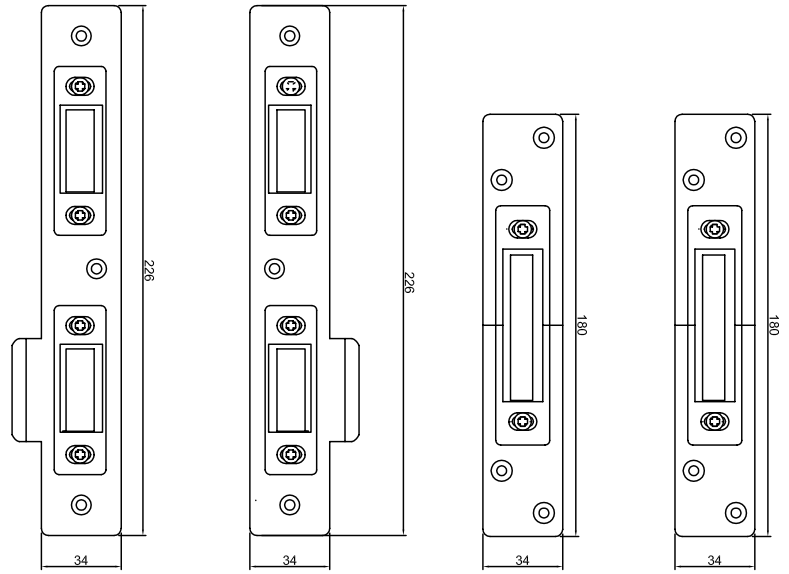

XLC0001-KE  
Centre Keep

XLC0002-KE  
Centre Keep

XLC0005-KE  
Bolt Keep

XLC0007-KE  
Hook Keep

## XL CRIMEBEATER

2100mm x 44mm  
White PVCu

1720mm x 20mm  
Silver Passivated

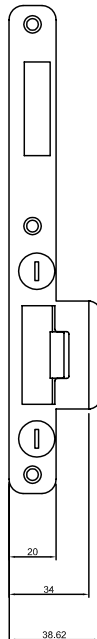
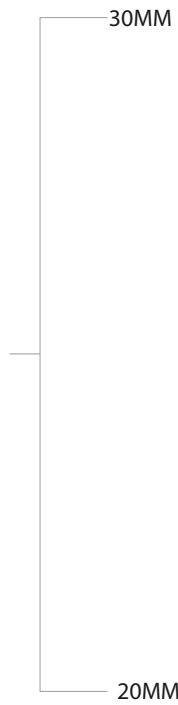

XCKCR

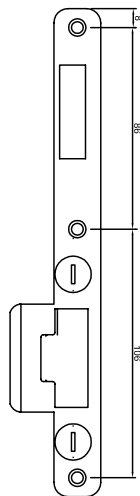

XCKCL

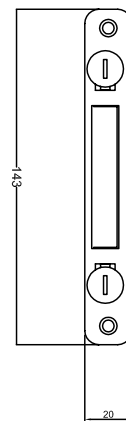

CRB00012-KE  
Hook Keep

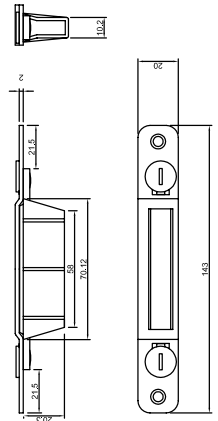

XCKS  
Bolt Keep

# fullex<sup>®</sup> CRIMEBEATER

## SINGLE DOORS

Fullex Crimebeater is engineered to provide long term reliability and security. Widely specified, Fullex Crimebeater has been fitted to hundreds of thousands of doors in the UK.

With 3 deadbolt and 2 hook and deadbolt variants available, in 20mm 304 stainless steel or 44mm wrap around white aluminium powder coated faceplates, Crimebeater is not only secure, but adaptable.

Crimebeater is UKAS tested to PAS 24 standard and licensed to the Police approved Secured by Design standard.

Composite Doors

Timber Doors

PAS 24 tested

2 tapered steel hooks, deadbolt and latch or 3 deadbolts and latch

Dual or single spindle option

Integral hold back latch function on lock faceplate

Easily reversible latch as standard

Various adjustable security keep sets available

For use with composite and timber doors



### Technical Data

#### Corrosion Resistance

BS EN 1670 Grade 5 (480 hours)

#### Cycle Operation

Cycle tested to 100,000 operations

### Materials

#### Top and Bottom Hook

Chrome plated A3 hardened cast steel

#### Deadbolt

Chrome plated A3 hardened cast steel

#### Centre Deadbolt

CZ122 brass stamping

#### Faceplate

20mm 304 austenitic stainless steel or 44mm white aluminium powder coated

#### Gearbox

Zinc and clear passivated mild steel

For maximum security this lock can be used with the Kinetica K4 3 star BSI Kitemarked TS007 cylinder.



Secured by Design



Police Preferred Specification

PAS 24

ENHANCED SECURITY PERFORMANCE APPROVED

Available in dual spindle for use with 92mm/92mm or 92mm/62mm long backplate handles.

The 44mm faceplate version has a matching white hinge plate, either blank or prepared for Crimebeater door hinges.

Faceplate: 1720mm x 20mm (Stainless Steel)  
700mm Centres



Spindle	Backset Size	Handle Backplate	Handle Centres	No of Hooks	No of Deadbolts	No of Mushrooms	Product Code
Dual	35mm	243mm	92mm or 92/62mm	0	3	0	CRB0001
Dual	45mm	243mm	92mm or 92/62mm	0	3	0	CRB0002
Dual	55mm	243mm	92mm or 92/62mm	0	3	0	CRB0003
Dual	35mm	243mm	92mm or 92/62mm	2 (down)	1	0	CRB0004
Dual	45mm	243mm	92mm or 92/62mm	2 (down)	1	0	CRB0005

Faceplate: 2100mm x 44mm (White Aluminium)  
700mm Centres



Spindle	Backset Size	Handle Backplate	Handle Centres	No of Hooks	No of Deadbolts	No of Mushrooms	Product Code
Dual	35mm	243mm	92mm or 92/62mm	0	3	0	CRB0027
Dual	45mm	243mm	92mm or 92/62mm	0	3	0	CRB0028
Dual	35mm	243mm	92mm or 92/62mm	2 (down)	1	0	CRB0030
Dual	45mm	243mm	92mm or 92/62mm	2 (down)	1	0	CRB0031

**ACCESSORIES**

Description	Product Code
White plastic hinge infill	CL0097
White plastic infill plus 5mm leg	CL102
Brown plastic hinge infill	CL103
Hinge plate to suits Crimebeater 3D and cranked hinge	21171P-10
20mm cylinder guard	70018
24mm cylinder guard	70017

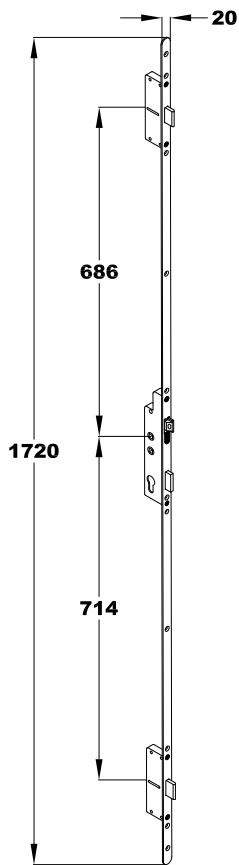

1720mm x 20mm (bolts)

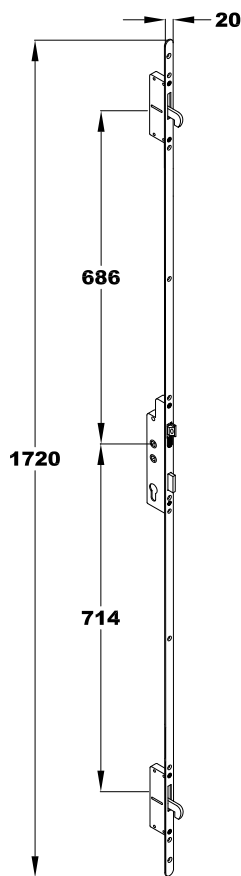

1720mm x 20mm (hooks)

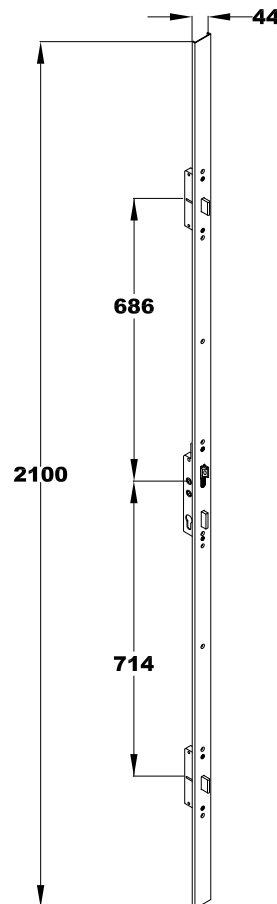

2100mm x 44mm (bolts)

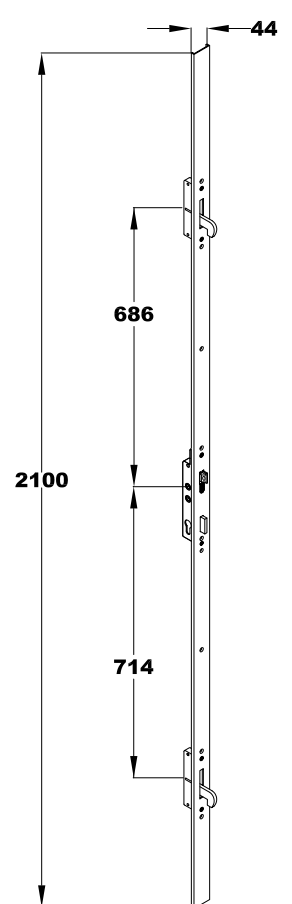

2100mm x 44mm (hooks)

# KEEPS

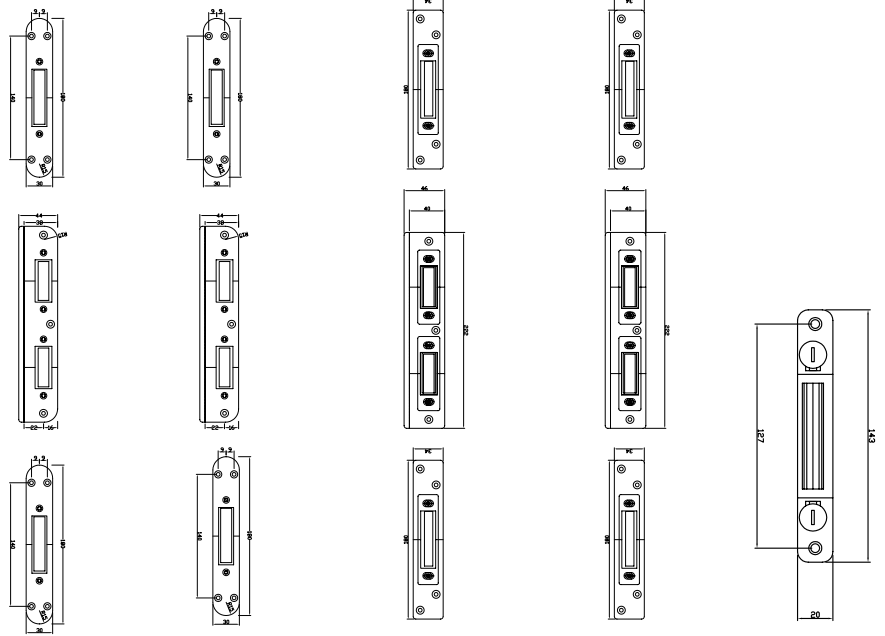

CRB0005-KE  
FULL SET HOOK  
KEEP  
Non handed

CRB0004-KE  
FULL SET BOLT  
KEEP  
Non handed

CRB0001-KE  
FULL SET HOOK  
Non handed

CRB0008-KE  
FULL SET BOLT  
KEEP  
Non handed

CRB00012-KE  
BOLT KEEP  
Non handed

Ideal for solid timber doors non  
Handed will work with all CRB  
range . Not for Fire doors

## CRIMEBEATER BOLTS

1720mm x 20mm  
2100mm x 44mm

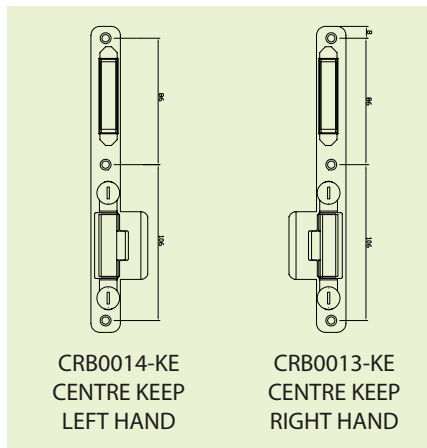

CRB0014-KE  
CENTRE KEEP  
LEFT HAND

CRB0013-KE  
CENTRE KEEP  
RIGHT HAND

+

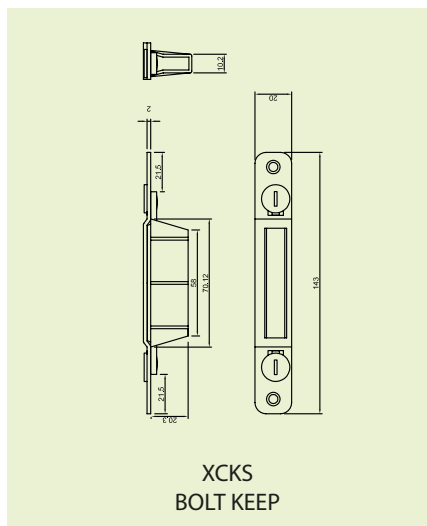

XCKS  
BOLT KEEP

**MOST POPULAR  
COMBINATION**

Autolock on GRP or FD30/60 Timber  
doors. Will work with our Intumescent  
kits . Also work with Keywind



# fullex<sup>®</sup> CRIMEBEATER 220 PRO

## SINGLE DOORS

The Crimebeater 220 Pro is suitable for composite and timber doors.

Boasting exceptional security, the Crimebeater Pro 220 is a great choice for an inexpensive multipoint lock.

Each Crimebeater 220 Pro lock is Zinc and clear passivated.

This combination ensures corrosion resistance quality, creating a long lasting, durable product.

Composite Doors

Timber Doors

Designed for volume door manufacturers

Deadbolt throws when the handle is lifted

2 opposing steel hooks, deadbolt and latch

Inline split spindle lock

Easily reversible latch

Includes latch hold back snib on lock faceplate

1570mm x 20mm or 1770mm x 20mm faceplate with radius ends

For use on composite and timber doors

Comes with a 10 year guarantee

Corrosion resistant unhandled stainless steel keep set



### Technical Data

#### Corrosion Resistance

BS EN 1670 Grade 4 for 240 hours

#### Cycle Operation

Cycle tested to 50,000 operations

### Materials

#### Top and Bottom Hook

Hardened cast steel

#### Faceplate

Mild steel, zinc and clear passivated

For maximum security this lock can be used with the Kinetica K4 3 star BSI Kitemarked TS007 cylinder.



Secured by Design



Police Preferred Specification



Faceplate: 1570mm x 20mm (Zinc and Clear Passivated)

Spindle	Backset Size	Handle Backplate	Handle Centres	No of Hooks	No of Deadbolts	No of Mushrooms	Product Code
Split	45mm	219 or 243mm	92mm	2 (opposing)	1	0	CRB 220 PRO HK 45MM

Faceplate: 1770mm x 20mm (Zinc and Clear Passivated)

Spindle	Backset Size	Handle Backplate	Handle Centres	No of Hooks	No of Deadbolts	No of Mushrooms	Product Code
Split	45mm	219 or 243mm	92mm	2 (opposing)	1	0	CRB 220 PRO 710-719

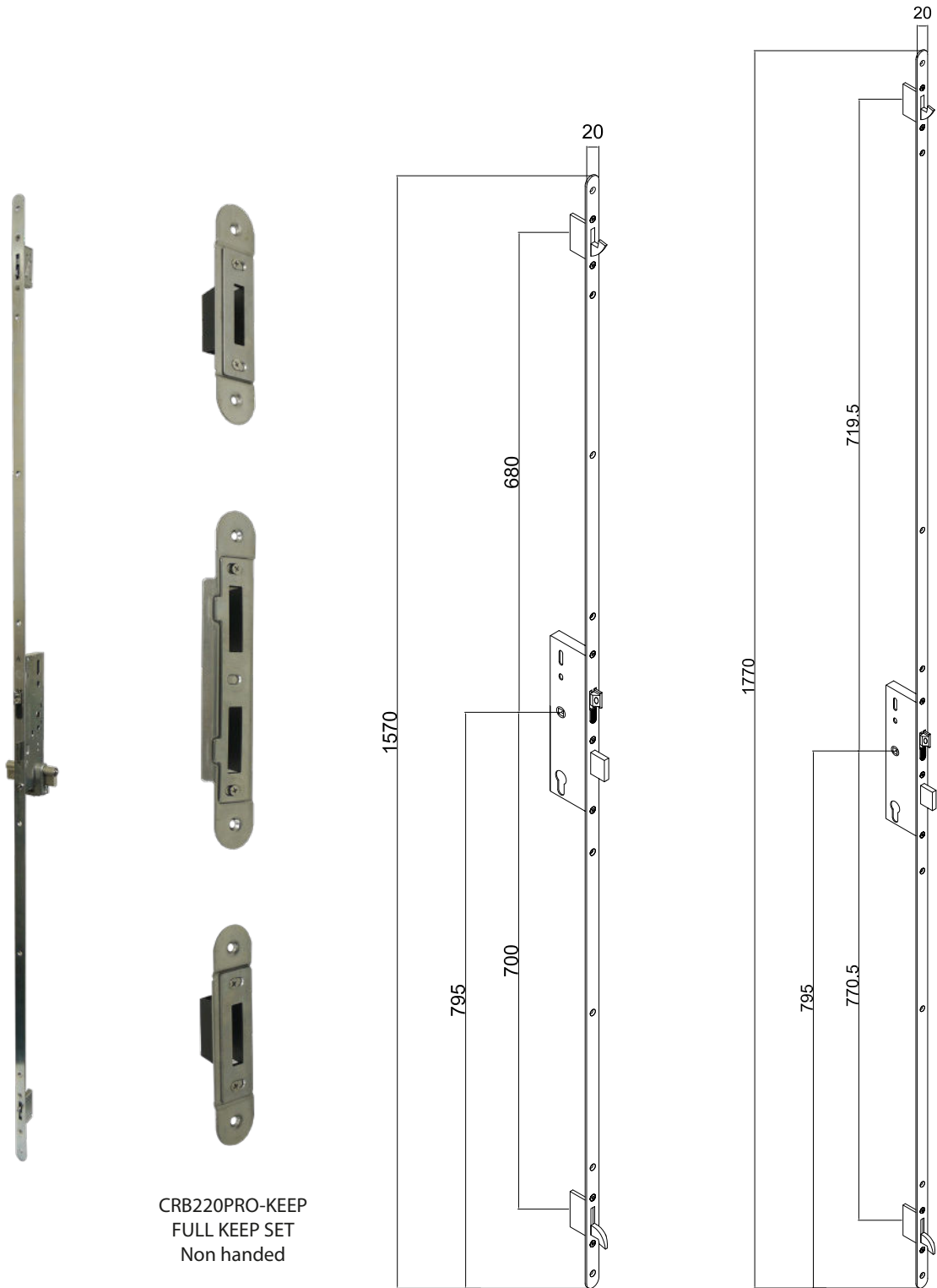

CRB220PRO-KEEP  
FULL KEEP SET  
Non handed

CRB220PRO-1570

CRB220PRO-1770

# fullex<sup>®</sup> SL16 MULTIBOLT

## SINGLE DOORS

The SL16 Multibolt has gained an enviable reputation in all markets for strength and reliability in over 17 years of successful service.

Performing to in excess of 9Kn during PAS 24 testing, SL16 is one of the most secure locks available and is widely used on PVCu, Composite, Timber, Steel and Aluminium doors.

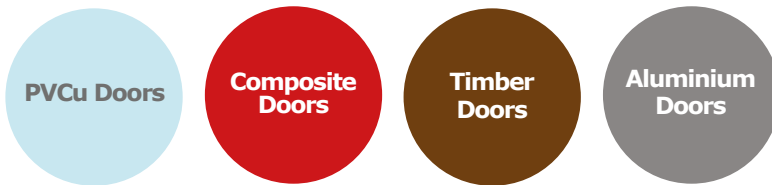

PAS 24 tested

Inline split spindle

Integral hold back latch function on lock faceplate

Easily reversible latch as standard

Various adjustable security keep sets available

Possible to have an additional single hook



### Technical Data

#### Corrosion Resistance

BS EN 1670 Grade 5 (480 hours)

#### Cycle Operation

Cycle tested to 100,000 operations

### Materials

#### Top and Bottom Bolts

CZ122 brass stamping

#### Deadbolt

Chrome plated A3 hardened cast steel

#### Centre Deadbolt

CZ122 brass stamping

#### Faceplate

20mm 304 austenitic stainless steel

#### Gearbox

Zinc and clear passivated

### Secured by Design



Police Preferred Specification



For maximum security this lock can be used with the Kinetica K4 3 star BSI Kitemarked TS007 cylinder.



The SL16 deadbolts are chamfered to pull in smoothly and have a 20mm long throw for maximum security on any door type.

Faceplate: 1770mm x 20mm (Stainless Steel)

Spindle	Backset Size	Faceplate Width	Handle Backplate	Handle Centres	Latch Size	No of Hooks	No of Deadbolts	Product Code
Split	35mm	20mm	240mm	68PZ	51mm	0	3	SL160053
Split	35mm	20mm	240mm	68PZ	51mm	1 (down)	3	SL160054
Split	45mm	20mm	240mm	68PZ	51mm	0	3	SL160108
Split	45mm	20mm	240mm	68PZ	51mm	1 (down)	3	SL160107
Split	55mm	20mm	240mm	68PZ	51mm	0	3	SL160074

Faceplate: 1770mm x 16mm (Stainless Steel)

Spindle	Backset Size	Faceplate Width	Handle Backplate	Handle Centres	Latch Size	No of Hooks	No of Deadbolts	Old Product Code
Split	35mm	16mm	240mm	68PZ	51mm	1 (down)	3	SL160005

Faceplate: 2200mm x 16mm (Stainless Steel)

Spindle	Backset Size	Faceplate Width	Handle Backplate	Handle Centres	Latch Size	No of Hooks	No of Deadbolts	Product Code
Split	35mm	16mm	240mm	68PZ	51mm	0	3	SL160004

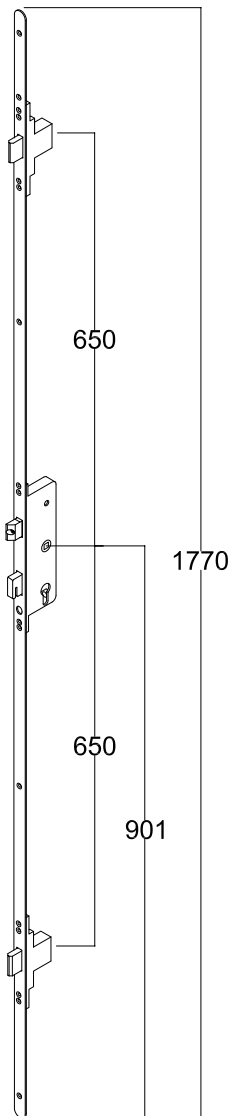

1770mm  
(bolts)

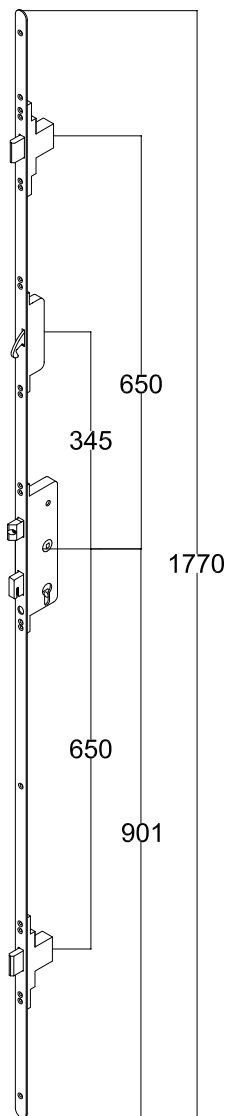

1770mm  
(hooks)

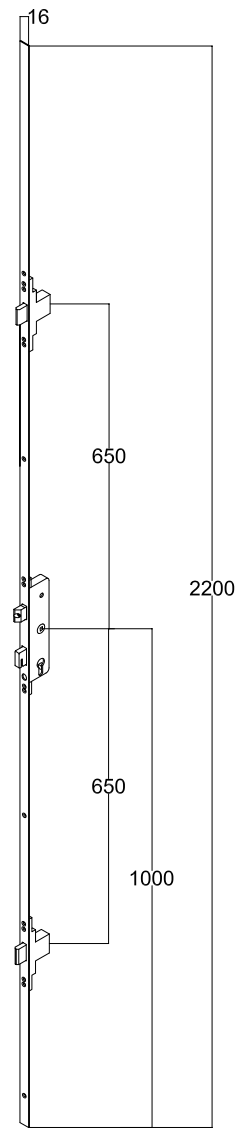

2200mm x 16mm

# KEEPS

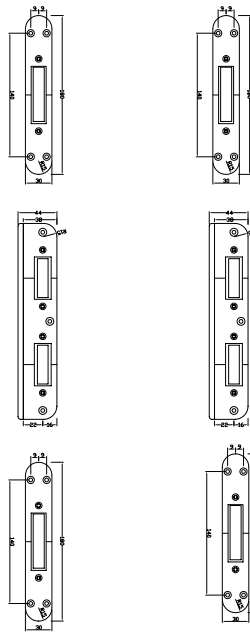

CRB0005-KE  
FULL SET HOOK  
KEEP  
Non handed

CRB0004-KE  
FULL SET BOLT  
KEEP  
Non handed

Ideal for solid timber doors non  
Handed will work with all CRB  
range.

## SL16 MULTIBOLT BOLTS 1770mm

2200mm x 16mm

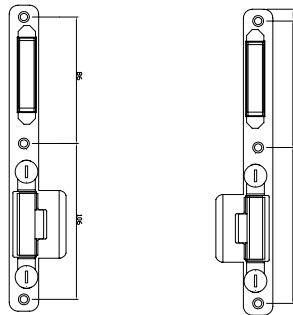

CRB0014-KE  
CENTRE KEEP  
LEFT HAND

CRB0013-KE  
CENTRE KEEP  
RIGHT HAND

+

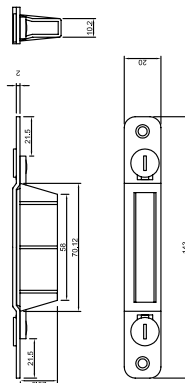

XCKS  
BOLT KEEP



**SL16 MULTIBOLT  
HOOKS**  
1770mm

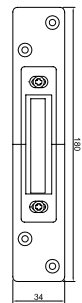
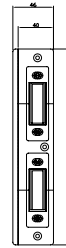
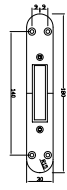
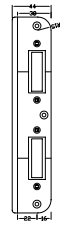
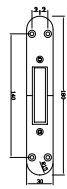

CRB0005-KE  
FULL SET HOOK  
KEEP  
Non handed

XLC0008-KE

CRB0001-KE  
FULL SET HOOK  
KEEP  
Non handed

XLC0007-KE

Ideal for solid timber doors non  
Handed will work with all CRB  
range.

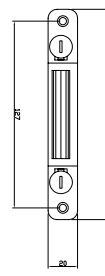
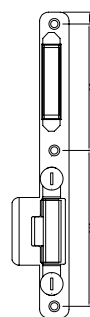
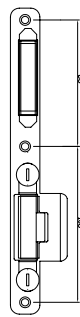

CRB0014-KE  
CENTRE KEEP  
LEFT HAND

CRB0013-KE  
CENTRE KEEP  
RIGHT HAND

CRB0012-KE  
HOOK KEEP  
Non handed

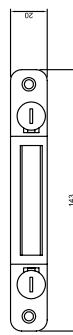
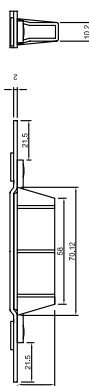

XCKS  
BOLT KEEP

# fullex<sup>®</sup> *DIRECT FIX TIMBER DOUBLE DOOR LOCK*

The Direct Fix Double Door lock is based on the 220 Pro lock mounted on a 16mm full height cover plate for the master door, the slave door side is also based on the 220 Pro centre case in a

simplified version with keep adjustment incorporated onto the faceplate. The lock is made to fit directly into the edges of a over-rebated double door set.



Deadbolt throws when the handle is lifted

2 opposing steel hooks, deadbolt and latch

Inline split spindle lock

Easily reversible latch

Includes latch hold back snib on lock faceplate

2200mm X 16mm square ends

Composite and timber over rebated double doors

Comes with a 10 year guarantee

Keeps are integrated into the slave door lock face plate

Comes with an anti-drill plate for extra security



**Secured by Design**



Police Preferred Specification



For maximum security the Timber Double Door Lock can be used with the Kinetica 3 star BSI Kitemarked TS007 cylinder.





# fullex<sup>®</sup> *GEMINI DOUBLE*

## DOUBLE AND STABLE DOORS

With a range of hardware and attractively finished extrusions available for 44mm composite doors and with a direct fit option for Timber doors, Fullex Gemini is adaptable and secure.

Composite  
Doors

Timber  
Doors

Creates a fully  
rebated door

PAS 24 tested

Tapered top and bottom deadbolts offer high security and compression

Double operating handle option or dummy external handle to slave

Split spindle option for use on front door applications

304 grade stainless steel faceplate and slave lock for high corrosion resistance



### Technical Data

#### Corrosion Resistance

BS EN 1670 Grade 5 (480 hours)

#### Cycle Operation

Cycle tested to 100,000 operations

### Materials

#### Top and Bottom Dead Bolts

CZ122 brass stamping

#### Deadbolt

CZ122 brass stamping

#### Faceplate

304 austenitic stainless steel

#### Gearbox

Zinc and clear passivated

#### Carrier Extrusions

White or anodised silver and gold

Secured by Design



Police Preferred Specification

PAS  
24

ENHANCED  
SECURITY  
PERFORMANCE  
APPROVED

For maximum security this lock can be used with the Kinetica K4 3 star BSI Kitemarked TS007 cylinder.



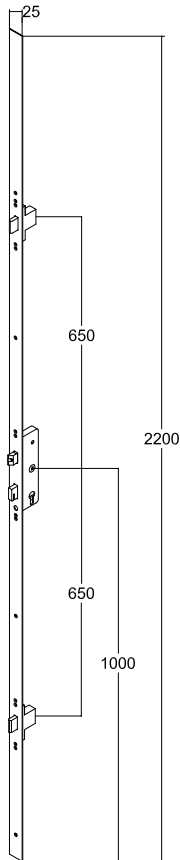

Finish	Product Code Left Hand Opening Out	Product Code Right Hand Opening In
White Painted	FULLEX-GEMINI-LH-WHITE	FULLEX-GEMINI-RH-WHITE
Silver Anodised	FULLEX-GEMINI-LH-SILVER	FULLEX-GEMINI-RH-SILVER
Gold Anodised	FULLEX-GEMINI-LH-GOLD	FULLEX-GEMINI-RH-GOLD

**SL16 Lock Faceplate: 2150mm x 25mm (Stainless Steel)**

Spindle	Backset Size	Faceplate Width	Handle Backplate	Handle Centres	No of Deadbolts
Split	45mm	25mm	240mm	68PZ	3



**SL16 Lock**

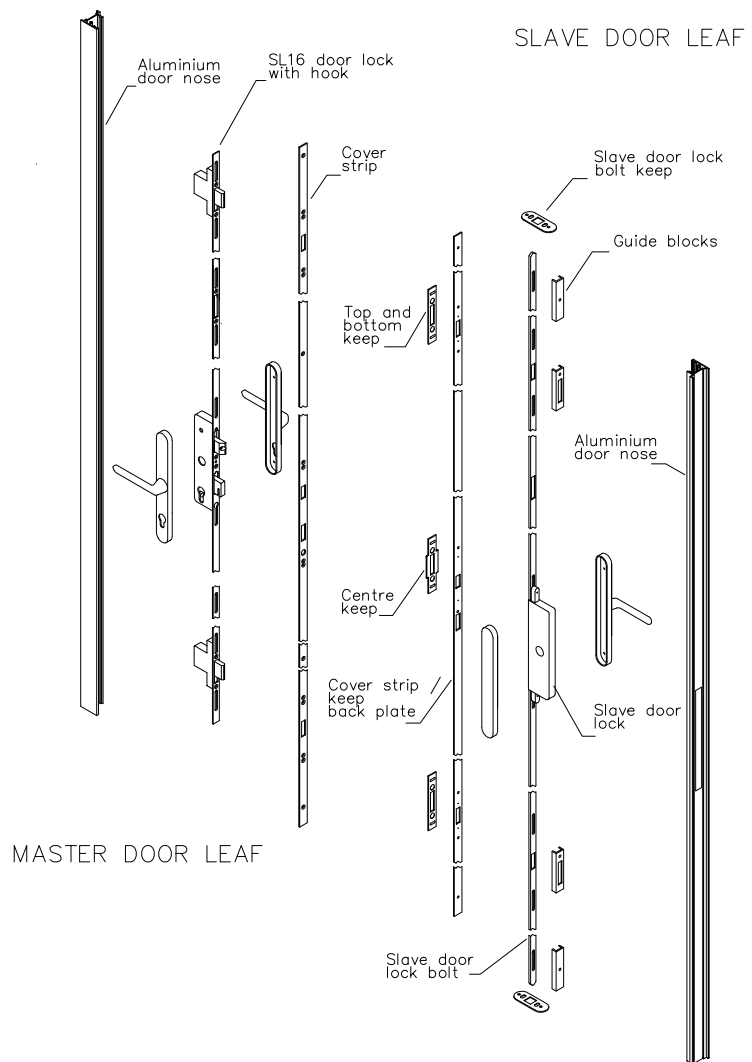
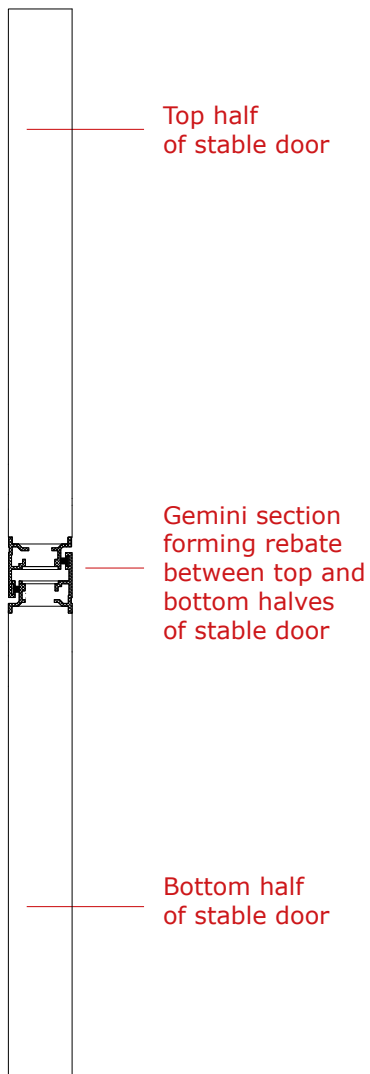

# fullex<sup>®</sup> PATIO LOCK

## PATIO AND SLIDING DOORS

Fullex Patio Door Lock has been designed to offer high security and long term reliability. It is available in 2 versions: 1414mm 6 hook and 1753mm 8 hook. They are suitable for all major PVCu profiles and boast exceptional security as well as durability.

Each Patio Door Lock has been manufactured using Austenitic stainless steel, offering maximum corrosion resistance and creating a long lasting, durable product.

As with all Fullex Locks, the Patio Door Lock is both Secured by Design licenced and PAS 24 tested.



PAS 24 tested

Available in 1414mm 6 hook and 1753mm 8 hook versions

Opposing stainless steel hooks and centre anti-lift bolt

Inclusive mishandling device to prevent damage to lock and keep

Shootbolt extendable at top and bottom as standard

One piece stainless steel keep



### Technical Data

#### Corrosion Resistance

BS EN 1670 Grade 5 (480 hours)

#### Cycle Operation

Cycle tested to 100,000 operations

### Materials

#### Top and Bottom Hook

Stainless Steel

#### Anti Lift Bolt

Stainless Steel

#### Faceplate

Stainless Steel

#### Gearbox

Stainless Steel centre gearbox

#### One Piece Keep

Stainless Steel

For maximum security this lock can be used with the Kinetica K4 3 star BSI Kitemarked TS007 cylinder.



### Secured by Design



Police Preferred Specification



Whether you choose the 6 or 8 hook option, all hooks are opposing which makes it extremely difficult to lift them out. There is also a central anti-lift bolt to make this even more challenging.

On either Patio Lock, there is the option to add shootbolts at the top and the bottom. The shootbolts fire out securing the door further when it is locked.

Fullex Patio Locks have also been designed with an inclusive mishandling device. The device pushes in when the door is fully closed which then allows for the lock to be operated. This not only makes locking the door much smoother but also prevents damage to both the lock and the keep.

Faceplate: 1414mm x 16mm (Stainless Steel)

Spindle	Backset Size	Handle Centres	No of Hooks	Anti-Lift Bolts	Product Code
7mm	20mm	155mm	6 (opposing)	1	PD1000

Faceplate: 1753mm x 16mm (Stainless Steel)

Spindle	Backset Size	Handle Centres	No of Hooks	Anti-Lift Bolts	Product Code
7mm	20mm	155mm	8 (opposing)	1	PD2000

**ACCESSORIES**

Description	Product Code
16mm white end plug	PDKEP1016W
2 x 262mm shoot bolts and shoot bolts keeps	PDSB+KE
Patio door rollers	PDROLL

Ideal to be fitted with the UAP patio door handle

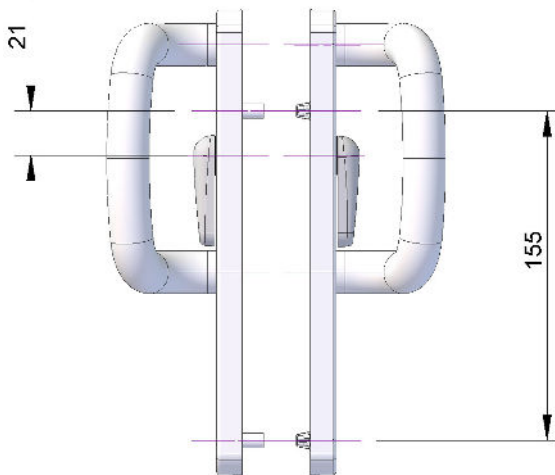

Patio Door Stops



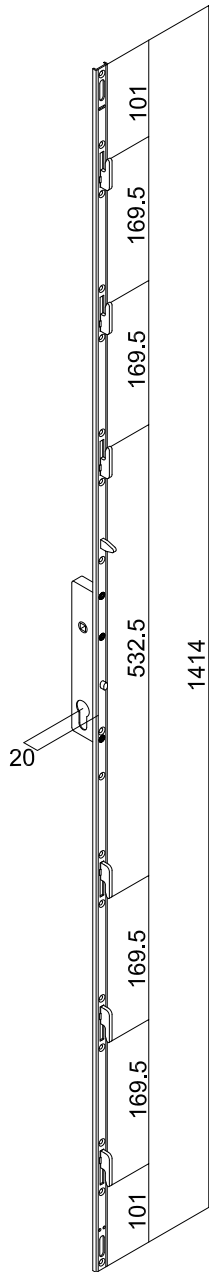

PD1000



PDK1012  
12mm 6 hook keep  
+  
Profile related  
packers



PDK1016  
16mm 6 hook keep  
+  
Profile related  
packers

Profile	Keep Profile	Product Code
Rehau and Decunick	02 / 12mm	PDLKP01
Profine Kommerling	02 / 12mm	PDLKP02
Eurocell	01 / 16mm	PDLKP03
Synseal and Selecta	01 / 16mm	PDLKP04
Halo Bowater / Veka	01 / 16mm	PDLKP05
Duraflex	01 / 16mm	PDLKP06
Spectus	01 / 16mm	PDLKP07
Plastmo / Profile 22	01 / 16mm	PDLKP08
Profine Kommerling	01 / 16mm	PDLKP09

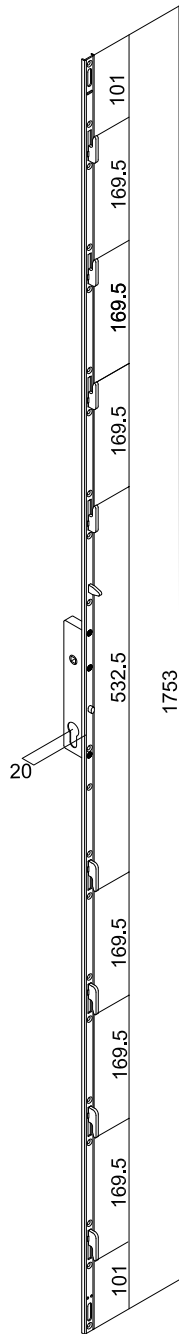

PD2000



PDK2012  
12mm 8 hook keep



PDK2016  
16mm 8 hook keep

Profile	Keep Profile	Product Code
Rehau and Decunick	02 / 12mm	PDLKP01
Profine Kommerling	02 / 12mm	PDLKP02
Eurocell	01 / 16mm	PDLKP03
Synseal and Selecta	01 / 16mm	PDLKP04
Halo Bowater / Veka	01 / 16mm	PDLKP05
Duraflex	01 / 16mm	PDLKP06
Spectus	01 / 16mm	PDLKP07
Plastmo / Profile 22	01 / 16mm	PDLKP08
Profine Kommerling	01 / 16mm	PDLKP09

# fullex<sup>®</sup> PATIO INTERLOCK

## PATIO AND SLIDING DOORS

The Fullex Patio Interlock kit is available for either a two pane or four pane single slider. Each kit contains a 8 hook PD2000, as well as rollers, shoot bolt set, Interlock lock, Interlock keeps and Interlock corner shoot bolts.

Secured by Design



Police Preferred Specification



PAS 24 tested

Interlock with Bi-directional hooks

Comes with a 10 year guarantee

Patent Pending

### A two pane single slider kit contains:

- One 8 hook patio lock PATIO-8HOOKS
- One 8 hook patio keep, 12 or 16mm dependent on profile being used.
- One pair of stainless steel patio rollers.
- One shoot bolt set.
- One interlock lock.
- One set of interlock keeps.
- One interlock corner shoot bolt.

### A four pane single slider kit contains:

- One 8 hook patio lock PATIO-8HOOKS
- One 8 hook patio keep, 12 or 16mm dependent on profile being used.
- One pair of stainless steel patio rollers.
- One shoot bolt set.
- Two interlock locks.
- Two sets of interlock keeps.
- Two interlock corner shoot bolts.



### Technical Data

**Corrosion Resistance**  
BS EN1670 Grade 5 for 480 hours

**Cycle Operation**  
Cycle tested to 50,000 operations

### Materials

**Top and Bottom Hook**  
A3 Steel

**Anti Lift Bolt**  
A3 Steel

**8 Hook Patio Lock Faceplate**  
202 stainless steel

**8 Hook Patio Gearbox**  
202 stainless steel

**Interlock Faceplate**  
304 stainless steel

**Interlock Gearbox**  
Mild steel zinc plated

For maximum security this lock can be used with the Kinetica K4 3 star BSI Kitemarked TS007 cylinder.



Interlock

Spindle	Backset Size	Handle Backplate	Handle Centres	No of Hooks	Anti-Lift Bolts
7mm	30mm	N/A	N/A	3 (down)	3

Patio 8 hooks lock

Spindle	Backset Size	Handle Backplate	Handle Centres	No of Hooks	Anti-Lift Bolts
7mm	20mm	219mm	92mm	8 (opposite)	1

Patio 8 hooks lock

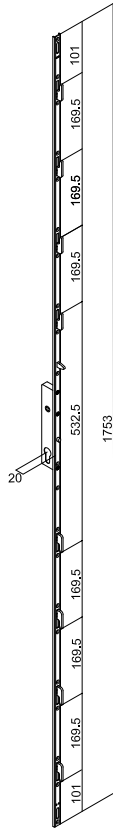

Two pane single patio Interlock kit

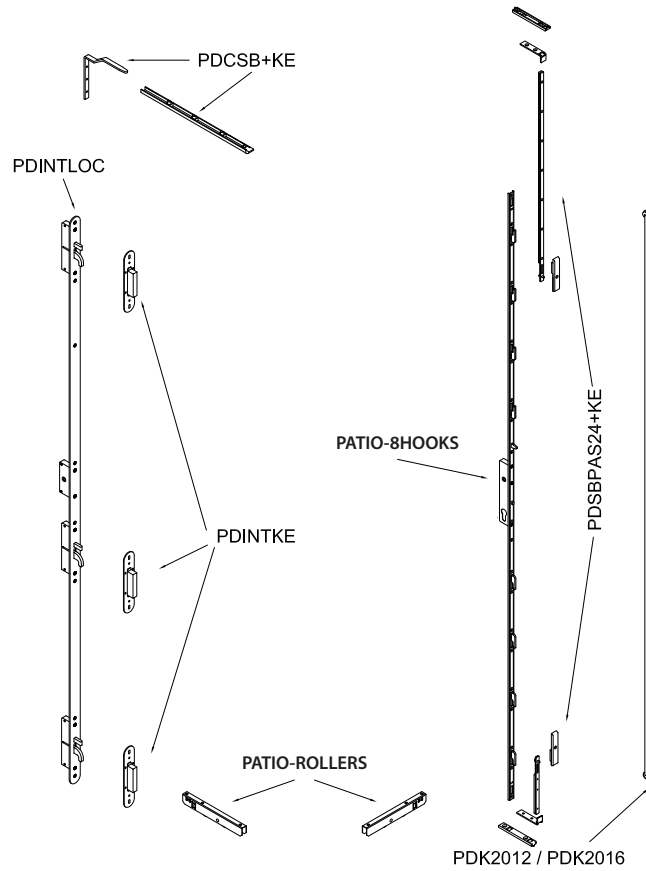

Type	Product Code
2 pane single slider kit	H038
4 pane single slider kit	H054

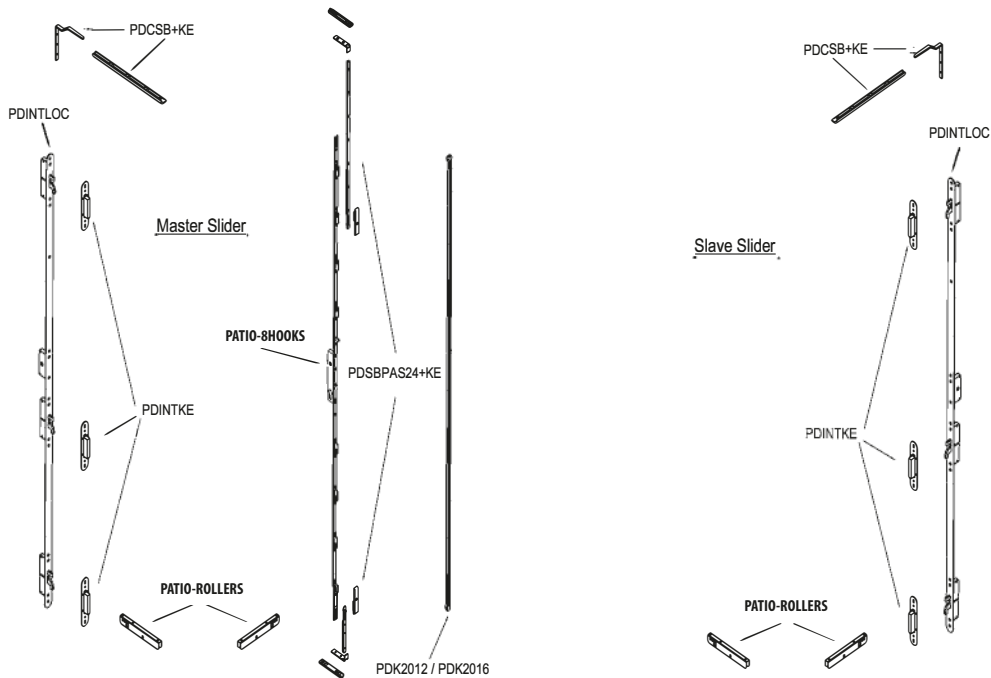

Four pane two slider patio interlock kit

ACCESSORIES

Description	Product Code
Patio door rollers	PDROLL
Interlock handle white	PDINTHW
Interlock handle black	PDINTHB
Interlock handle chrome	PDINTHC



# fullex<sup>®</sup> BIN LOCK

## BIN STORAGE DOORS

The Fullex Bin Store lock offers a secure and reliable temporary security solution.

Suitable as a temporary lock to replace the majority of multi point locks while a replacement

is sourced; the Bin Store Lock is designed for professional installers. In the event that a suitable lock is not immediately available, the Bin Store Lock can be used as a temporary security solution.



Secured by Design



Police Preferred Specification



For use on timber and composite doors

Available in dual spindle

Easily reversible latch

Includes latch hold back snib on lock faceplate

Comes with a universal, unhanded keep

Tested to 200,000 full cycles

Corrosion resistance tested to BS EN 1670 Grade 4 for 240 hours



### Technical Data

#### Corrosion Resistance

BS EN 1670 Grade 4

#### Cycle Operation

Cycle tested to 200,000 cycles

### Materials

#### Hook

Sintered AB steel

#### Faceplate

Zinc and clear passivated

#### Gearbox

Zinc and clear passivated



XLC0009-KE  
Non handed  
centre keep

XLC0001-KE  
LEFT HAND

XLC0002-KE  
RIGHT HAND

For maximum security the Bin Lock can be used with the Kinetica K4 3 star BSI Kitemarked TS007 cylinder.



Faceplate = 300mm x 20mm (Zinc & Clear Passivated)

Spindle	Backset Size	Handle Backplate	Handle Centres	No of Hooks	Product Code
Dual	45mm	243mm	92mm or 62/92mm	1	FULLEX-BIN-LOCK-45
Dual	55mm	243mm	92mm or 62/92mm	1	FULLEX-BIN-LOCK-55

Each lock comes with a universal keep, meaning there is no need to stock both left hand and right hand keeps or worry about fitting them incorrectly. The backset size is 45mm and the faceplate is 300mm by 20mm, zinc and clear passivated as standard.

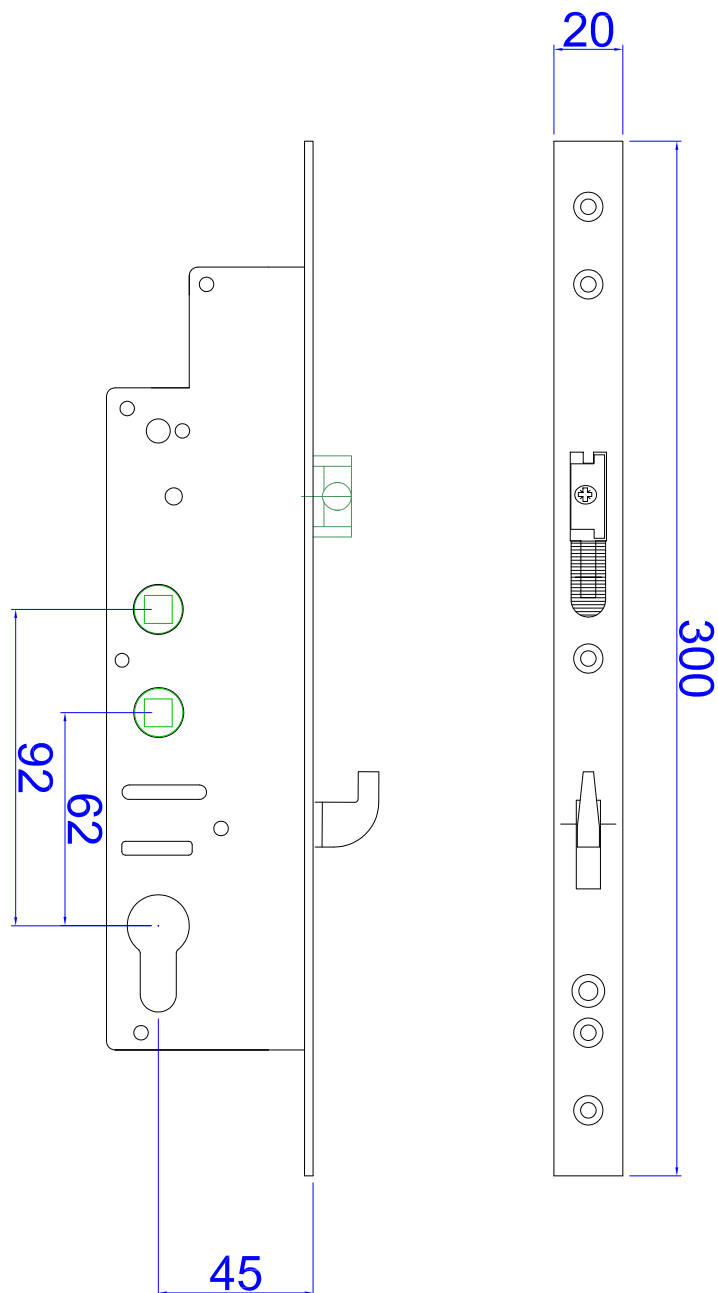

# fullex<sup>®</sup> uPVC UNIVERSAL REPAIR LOCK

## uPVC DOORS

The Fullex Universal Repair Lock offers a secure and reliable security solution.

The Fullex Universal Repair Lock is designed to replace uPVC doors with a 35mm backset

and 16mm faceplate. The kit contains a three piece lock, a three piece keep and comes with optional to fit keep tidy plates. The lock has an easily reversible latch with snib.



PVCu Doors

Easily reversible latch with snib

---

Available in dual spindle

---

Split spindle

---

Includes latch hold back snib on lock faceplate

---

Comes with a universal, unhanded keep

---

Tested to 200,000 full cycles

---

Corrosion resistance tested to BS EN 1670 Grade 4 for 240 hours

---



### Technical Data

#### Corrosion Resistance

BS EN 1670 Grade 4

#### Materials

##### Hook

A3 hardened cast steel

##### Faceplate

Dacromet coated A3 sintered steel

##### Gearbox

A3 Zinc and clear passivated



Spindle	Backset Size	Handle Backplate	Handle Centres	No of Hooks	Product Code
Split	35mm	219mm or 243mm	92mm or 62/92mm	1	FULLEX-UPVC-REPAIRLOCK

### Kit contents

#### 1x Lock (3 parts)

Hook

Connector rod and cover plate

Centre case

Connector rod and cover plate

Hook

#### 1 Keep (3 parts)

Hook keep

Centre keep

Hook keep

#### 2x Tidy plate



# fullex<sup>®</sup> SLAM SHUT AUTOLOCK

## SINGLE DOORS

Based on the popular Crimebeater lock. The Slam Shut Autolock has an actuator unit positioned between the centre case and the top bolt.

When the door is closed a trigger in the actuator is depressed by a strike plate fitted to the outer frame

which allows the actuator to drive the top and bottom bolts into their extended position. A single rotation of the key then locks the door.

Available in dual spindle for use with 92mm/92mm or 92mm/62mm long backplate handles and is supplied complete with strike plate.

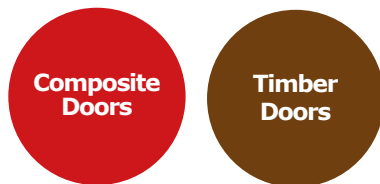

Based on the Fullex Crimebeater lock

---

Dual Spindle Lock

---

Supplied complete with strike plate

---

Easily reversible latch as standard

---

Tested to 50,000 full cycles

---

For use with composite and timber doors

---

Comes with a 10 year guarantee

---



### Technical Data

#### Corrosion Resistance

BS EN 1670 Grade 5 (480 hours)

#### Cycle Operation

Cycle tested to 50,000 operations

### Materials

#### Top and Bottom Hook

Chrome plated A3 hardened steel

#### Centre Deadbolt

CZ122 brass stamping

#### Faceplate

Zinc and clear passivated mild steel

#### Gearbox

Zinc and clear passivated mild steel

The Fullex Slam Shut Autolock is engineered to provide long term reliability and security. When combined with bespoke intumescent kits the

Fullex Slam Shut AutoLock has achieved FD30 & FD60 on timber dorsets and FD30 on composite doorsets.

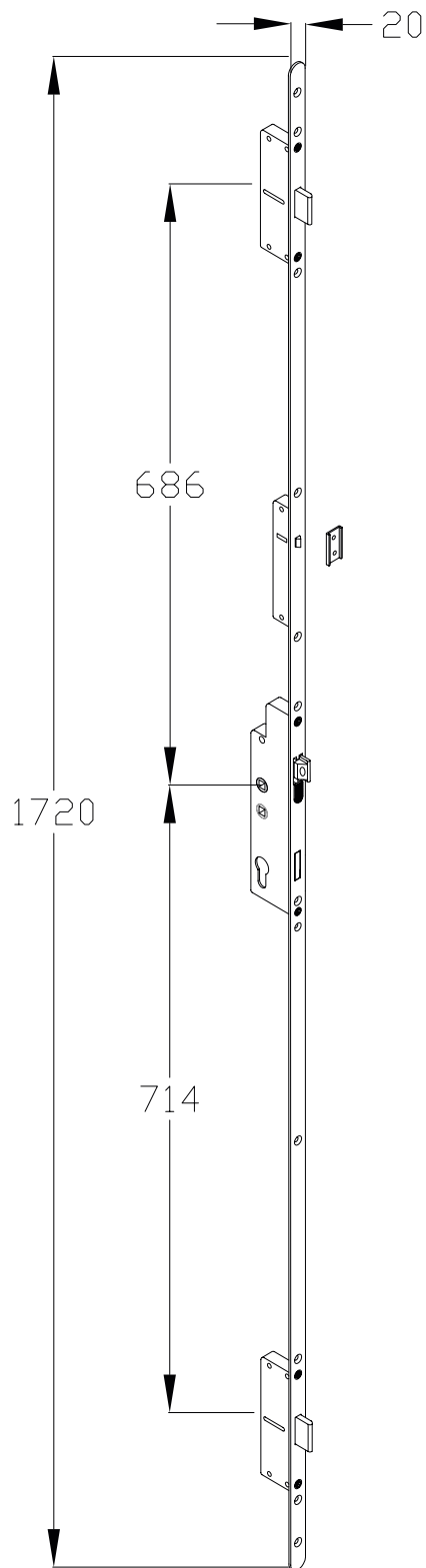

Composite Doors

Timber Doors



CRB0014-KE  
CENTRE KEEP  
LEFT HAND



CRB0013-KE  
CENTRE KEEP  
RIGHT HAND



XCKS  
BOLT KEEP

Faceplate: 1720mm x 20mm (Stainless Steel)  
700mm Centres

Spindle	Backset Size	Handle Backplate	Handle Centres	No of Hooks	No of Deadbolts	No of Mushrooms	Product Code
Dual	45mm	243mm	92mm or 92/62mm	0	3	0	FULLEX-CRB-AUTOLOCK

**KEEP SETS**

Type	Product Code Left	Product Code Right	Product Code Bolt Keep
Radius	CRB00014-KE	CRB00013-KE	XCKS

# fullex<sup>®</sup> KEEP SETS

## XL Lock

### One Piece Keeps

Handed	Lock Type	Centres	Old Product Code
Left	XL32R518	518mm	XLK2L518
Right	XL32R518	518mm	XLK2R518
Left	XL34R6357	635/572mm	XLK4LTH
Right	XL34R6357	635/572mm	XLK4RTH
Left	XL32R650	650mm	XLK2L650
Right	XL32R650	650mm	XLK2R650
Left	XL32R7474	735/758mm	XLK4L7474
Right	XL32R7474	735/758mm	XLK4R7474
None	XL2+2	673/706mm	XLK2+2 673/706 KEEP



### Individual Keeps

Handed	Lock Type	Position	Old Product Code
Left	All XL Locks	Centre	XLKCL
Right	All XL Locks	Centre	XLKCR
None	All XL 2 Roller Locks	Top and Bottom	XLKS2R
None	All XL 4 Roller Locks	Top and Bottom	XLKS4R



### Shoot Bolt Keeps

Pocket	Lock Type	Centres	Old Product Code
Yes	Double	All XL Locks	XLKBDSB
None	Double	All XL Locks	XLKDSB
None	Double Low Threshold	All XL Locks	XLKDSBLOW
Yes	Double (Slave door)	All XL Locks	XLKBSSB
None	Double (Slave door)	All XL Locks	XLKSSB
Yes	Single	All XL Locks	XLKBRSB
None	Single	All XL Locks	XLKRSB



## XL Crimebeater Lock

### Centre Keeps

	Left	Right
Square	XLC0001-KE	XLC0002-KE
Radius	XLC0003-KE	XLC0004-KE



### Centre Keeps

	Left	Right
Square	XLC0007-KE	XLC0008-KE
Radius	XLC0006-KE	XCKS



# KEEP SETS full<sup>®</sup>ex

## Crimebeater

Set of 3 (Fixed)



	Hook	Bolt
Square	CRB0001-KE Z/C	CRB0008-KE
Radius	CRB0005-KE	CRB0004-KE

Individual (Adjustable)



	Hook	Bolt
Left Centre	CRB0014-KE	CRB0014-KE
Right Centre	CRB0013-KE	CRB0013-KE
Top / Bottom	CRB0012-KE	CRB0012-KE

## Crimebeater 220 Pro



Handed	Lock Type	Size	Product Code
None	CRB220PRO	N/A	CRB220PRO-KEEP

## Patio Lock



Handed	Lock Type	Size	Old Product Code
None	6 Hook Lock	12mm	PDK1012
None	6 Hook Lock	16mm	PDK1016
None	6 Hook Lock	16mm	PDK1016M
None	8 Hook Lock	12mm	PDK2012
None	8 Hook Lock	16mm	PDK2016

## SL16 Multibolt



Handed	Lock Type	Old Product Code
None	All SL16 Locks	CRB0001-KE Z/C
None	SL16 Additional Hook Keep	CRB0009-KE

## Bin Store Lock



Handed	End Type	Product Code
None	Square	FULLEX-CRB0009-KE



# Drive progress with us

Speak to our specialist team

Sales Enquiries:  
[sales@uaplimited.com](mailto:sales@uaplimited.com)

All Enquiries:  
[enquiries@uaplimited.com](mailto:enquiries@uaplimited.com)

